

DRAWING FOR CUSTOMER

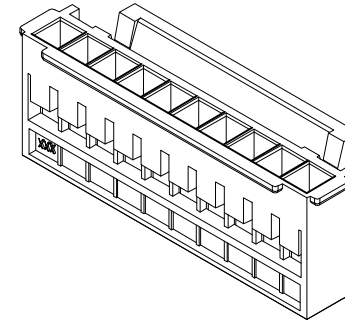
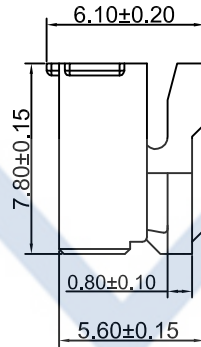
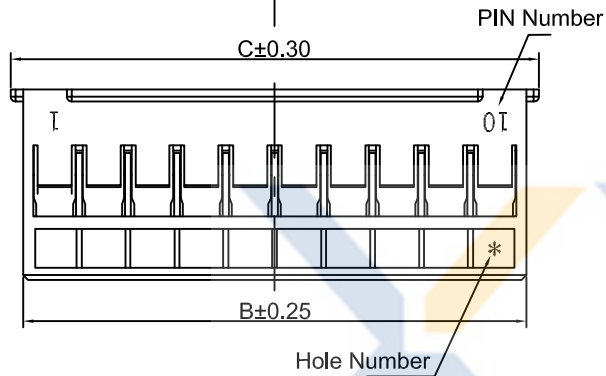
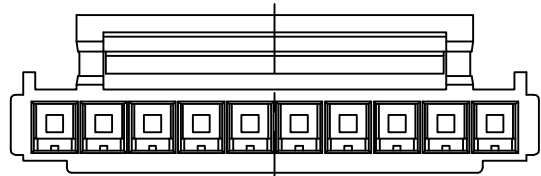

- SPEC.:
- Rated Voltage:250V AC,DC
 - Rated Current:3A AC,DC
 - Withstand Voltage:800V AC/minute
 - Contact Resistance:20mΩ max
 - Insulation Resistance:1000MΩ min
 - Temperature Range:-25℃~+85℃

- Material:
- Insulator:PA66 UL94V-0
 - Color:White

Poles	Dimensions(mm)			
	A	B	C	D
02	2.00	4.60	5.60	3.20
03	4.00	6.60	7.60	4.00
04	6.00	8.60	9.60	4.90
05	8.00	10.60	11.60	5.90
06	10.00	12.60	13.60	7.90
07	12.00	14.60	15.60	9.90
08	14.00	16.60	17.60	11.90
09	16.00	18.60	19.60	13.90
10	18.00	20.60	21.60	12.30
11	20.00	22.60	23.60	16.30
12	22.00	24.60	25.60	16.30
13	24.00	26.60	27.60	16.30
14	26.00	28.60	29.60	16.30
15	28.00	30.60	31.60	16.30
16	30.00	32.60	33.60	16.30

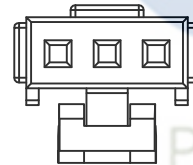
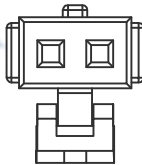
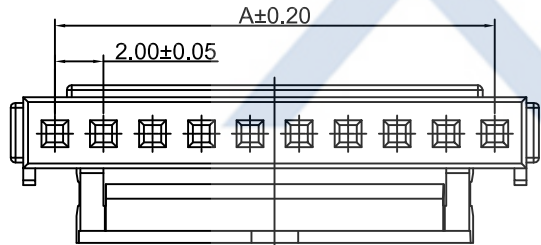

KB935-XXHL2A

Pin No. Version

Housing Mold No.

With Lock

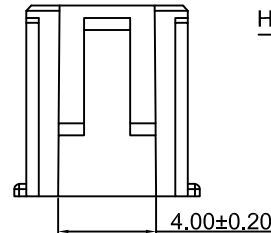
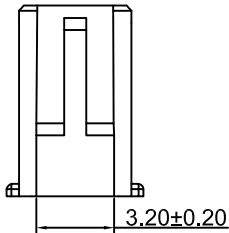
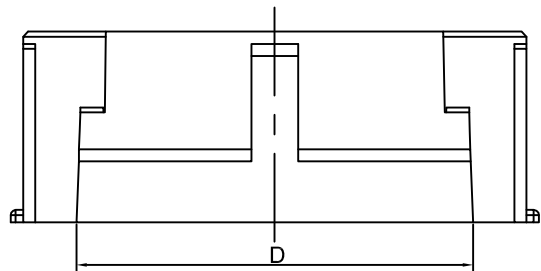

2 PIN

3 PIN

XYCO 东莞市轩业电子科技有限公司
 TEL: 0769-8297 9981/2/3 http://www.XYCO.com.cn

2014-08-01		A	CHANGE HISTORY 變更歷史	CHANGED NAME 修改後料號	DRAWING 變更者	TOLERANCE 公差	DRAWING 設計者	Devin	KB935-XXHL2A		UNIT 單位		PRODUCT NAME 產品名稱	PHS PH2.00 wire to board Housing with Lock
DATE 日期	VER 版本	KB935-XXHL2A				Devin	.X=±0.30	CHECKED 審查	Thomas	PART NO. 料號	mm			
							.XX=±0.20	APPROVED 核准	William	DWG NO. 圖號	PE1808003A			